

VENTO CYC

509543.372



MARCHI

Marks

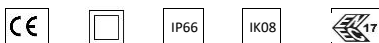

DATI PRODOTTO

Product Data

Tipologia di prodotto Product type	Armatura stradale / Street lighting					
Descrizione Description	VENTO CYC	740	90 W	850 mA	IP 66	AN
Grado di protezione Degree of protection	IP			66		
Protezione agli urti Impact protection	IK	08	J		5	
Temperatura colore Color temperature	[K]			4000		
Classe di isolamento IEC IEC Insulation class			II			
Temperatura operativa Operating temperature	[ta°]			-35/+50°C		
Garanzia standard Standard warranty	[Anni - Years]			5		
Regolazione della luce Light control	Standard *(1)			On-Off		

PRESTAZIONI APPARECCHIO

Luminaire Performances

Flusso nominale / Corrente Nominal flux / Current	Lm	17170	mA	850
Consumo nominale Nominal power	[W]		90	
Efficienza sorgente LED LED source efficiency	Lm/W		191	
Flusso netto Net flux	[Lm]		14572	
Consumo reale Total power	[W]		94,7	
Efficienza luminosa Luminous efficiency	[Lm/W]		154	
Classe Energetica Energy class (UE reg. 2019/2015)		A		

STANDARD NORMATIVI

Normative Standards

EN 60598-1, EN 60598-2-3, EN 62471,
EN 55015, EN 61547, EN 61000-3-2, EN 61000-3-3

MECCANICHE & DIMENSIONI

Mechanics & Dimensions

Dimensioni Dimensions	[mm]	500	*	270	*	140
Peso netto Net weight	[Kg]			5,44		
Dimensioni imballo Packing dimensions	[mm]	590	*	300	*	180
Peso lordo Gross weight	[Kg]			6,11		
Volume Volume	[m³]			0,032		
Q.tà prodotti per imballo Products q.ty per package	[N°]			1		
Q.tà imballi per pallet Packaged q.ty per pallet	[N°]			30		
Superficie esposta al vento Surface exposed to the wind	[m²]	F	0,135	L		0,044
Interassi di fissaggio staffa Bracket fixing distance	[mm - Ø]		-			-
Inclinazione Tilt angle	[°]			90		

PRESTAZIONI ELETTRICHE

Power Performances

Alimentazione Power	Driver elettronico / Electronic driver			
Tensione / Frequenza Input Voltage / Frequency	[V] / [Hz]	220 ÷ 240	-	50/60
Corrente di spunto Inrush current	[230V]	31	A	390 µsec
Fattore di potenza Power factor	[Cosφ]			0,95
Distorsione armonica THD Harmonic distortion THD	[%]			≤ 7
Protezione alla scarica *(2) Surge protection	[kV]			Line-Earth 6KV, Line-Line 10KV
Flicker Flicker	[%]			≤ 3
Umidità relativa Relative humidity	[%]			>95
Max. Prodotti in serie Max. pcs in series	CB B16A			10

509543.372

DISEGNO DIMENSIONALE

Dimensional drawing

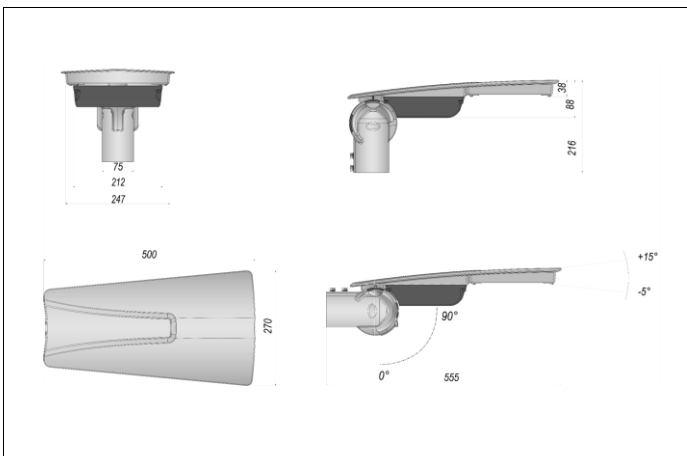

FOTOMETRIA POLARE

Polar photometry

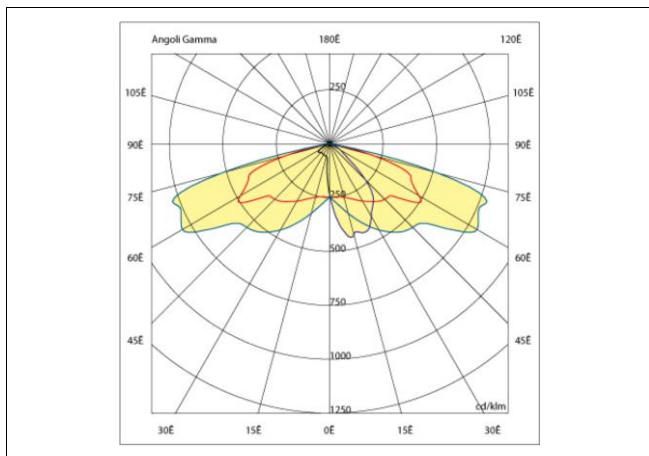

MATERIALI & FINITURE

Materials & finishing

Corpo Body	Alluminio Pressofuso / Aluminum Die Casting [UNI EN 1676:2010 - EN AB-46100]
Colore Colour	AN Antracite / Anthracite
Verniciatura Painting	Verniciatura tipo C4 / Painting class C4 [UNI EN ISO 12944] hr < 1000 [ISO 9227]
Diffuser Diffuser	Vetro float silicato sodico-calcico / Soda lime silicate float glass UNI EN 572-1.2
Riflettore Reflector	-
Viteria Screws	Acciaio INOX ASTM 304 A2
Guarnizione Gasket	Silicone / Silicon
Cablaggio incluso 1mt. Wiring included 1mt.	2 x 1,5 H07RN-F L=1mt
Resistenza alla nebbia salina Saline mist resistance	[hr] < 1000

SORGENTE LUMINOSA

Light source

Tipologia Sorgente Light Source	LED
Costruttore / N° / Modello Maker / N° / Model	SAMSUNG 36 LH502C
Indice di resa colore Color Rendering Index	[IRC] > 70
Uniformità colore Uniformity & Chromaticity	[SDCM] 3 Step mc Adams 740
Vita utile LED Expected LED lifetime	L80 B10 157,000h [Ta 25°C] L80 B10 133,000h [Ta 50°C]

SISTEMA OTTICO

Optical System

Distanza di soglia Distance from the lightned object	[cm]	150
Sicurezza fotobiologica Photobiological safety	Gruppo di rischio esente RG0 RG0 Risk-exempt group	
Ottica Optics	CYC	
Abbagliamento Molesto Light Output Ratio	[ULOR]	= 0%
Efficienza dell'ottica Optics efficiency	%	85% 0,85 100%
Flusso totale disperso Total lost flux	[%]	-
Materiale dell'ottica Optic material	PMMA Anti-UV [HB UL94 900° GWFI IEC 60695-2-12 SAE J576]	

DOTAZIONI EXTRA DISPONIBILI A RICHIESTA

Available Accessories on request

Regolazione della luce ^{*(1)} Light control	.cod+VM	Virtual Midnight
Regolazione della luce ^{*(1)} Light control	.cod+DALI	DALI2 Parts 25x + AUX 10...100 %
ZHAGA Cablato ZHAGA Wired	cod.+Z4W	Zhaga Book 18 + Driver DALI
Predisposizione ZHAGA ZHAGA ready	cod.+Z4	Zhaga Book 18 (Only Holder)



