

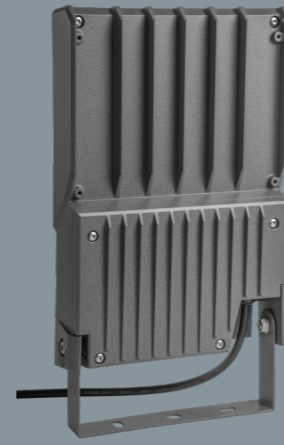

Gemini Lite **SM 1 COB 840**



Gemini Lite **AS 1 COB 840**



Gemini Lite **RETRO/BACK**

Proiettore compatto, nato per coniugare un design essenziale e contemporaneo, evoluzione tecnologica naturale di Joy. Perfetto per l'illuminazione di aree come giardini, ingressi, facciate, edifici e piazzali.

Compact LED floodlight, born to combine an essential with a contemporary design, Joy's technological evolution. Perfect for lighting areas such as gardens, entrances, facades, buildings and forecourts.

Corpo e cornice: realizzato in pressofusione di alluminio. Corpo alettato per massima dissipazione del calore.

Housing and frame: in die-cast aluminum. Housing with cooling fins for maximum heat dissipation.

Scala goniometrica laterale per la regolazione dell'orientamento.

Lateral goniometric scale for quick tilt adjustment.

Verniciatura: polvere di poliestere termoindurente, previo trattamento di sgrassaggio e fosfocromatazione in grado di garantire un'altissima resistenza agli agenti chimici ed atmosferici.

Paintwork: thermosetting polyester powder, prior degreasing and phosphochromatizing process that ensure an extremely high resistance to chemical and atmospheric agents.

Vetro di sicurezza: extra chiaro temprato da 4 mm.

Safety glass: extra clear tempered 4 mm.

LED: COB Samsung serie LC040D D-Gen3, CRI>80, CCT 4000K, SDCM 3.

LED: Samsung COB LC040D D-Gen3, CRI>80, CCT 4000K, SDCM 3.

Mantenimento del flusso luminoso: 50,000h L80 B10 @ta25, 30,000h L80 B10 @ta45.

Lumen maintenance: 50,000h L80 B10 @ta25, 30,000h L80 B10 @ta45.

Alimentazione: elettronica 220 ÷ 240V 50-60Hz, protezione alla scarica 1/2kV, cavo precablato 50cm 3x1mm² + M20 standard.

Power supply: 220 ÷ 240V 50-60Hz with electronic ballast, surge protection up to 1/2kV, prewired cable 50cm 3x1mm² + M20 standard.

Staffa di fissaggio: sagomata ed asolata in acciaio sp3 mm.

Bracket: 3 mm slotted and thick shaped steel.

SIMBOLOGIA / SIMBOLOGY pag. 8-9



COLORI DISPONIBILI / AVAILABLE COLOURS

3 COLORE STANDARD STANDARD COLOUR

Antracite
Anthracite

OPZIONI DI INSTALLAZIONE / INSTALLATION OPTIONS

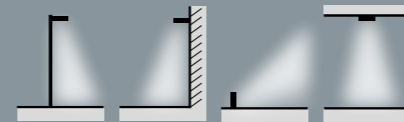

VERSIONI DISPONIBILI / AVAILABLE VERSIONS

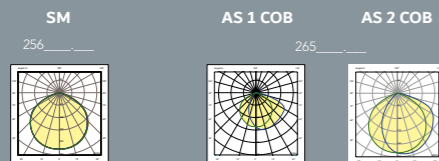

DIMENSIONI / DIMENSIONS

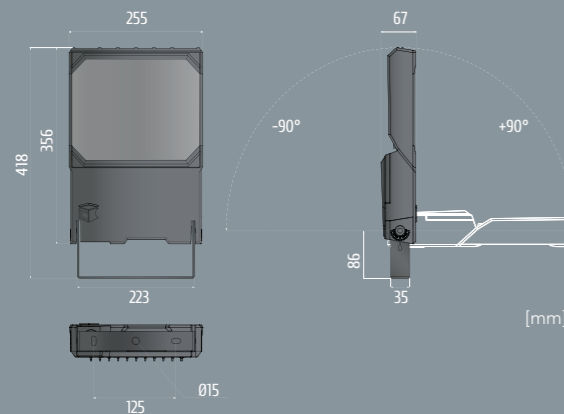

TEMPERATURA COLORE DISPONIBILE / COLOUR TEMPERATURE AVAILABLE pag. 58

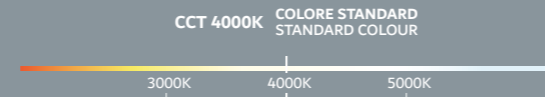

DISPONIBILI A RICHIESTA / AVAILABLE ON REQUEST

- driver DALI e riduzione di flusso con sistema Vmidnight;
- versione CRI90,*
- SPD 12kV;
- verniciatura speciale: colore e tipologia di ciclo di verniciatura (C5).
- DALI dimmable driver and output reduction with Vmidnight system;
- CRI90 version,*
- SPD 12kV;
- special paintwork: colour and type of corrosion painting cycle (C5).

ACCESSORI / ACCESSORIES pag. 27

- adattatore palo "T" Ø 40/60 mm;
- adattatore a palo "Deco" Ø 40/60 mm;
- griglia di protezione (IK10)*
- "T" pole adapter Ø 40/60 mm;
- pole adapter "Deco" Ø 40/60 mm;
- protection grid (IK10)*

DIMENSIONI IMBALLO / PACKING DIMENSIONS

m³ 0,010
470x275x80mm

1 Pcs
60 pcs



CODICE Code	DESCRIZIONE Description	POTENZA Power(W)	FLUSSO NOMINALE Typical flux(lm)	FLUSSO NETTO Net output(lm)	SPD Spd(kV)	CORRENTE Current(mA)	PESO NETTO Net weight(Kg)	
SM	256643.121	1 COB 840	21W	3870	3255	1/2	600	4,15
	256643.131	1 COB 840	30,5W	5660	4755	1/2	900	4,25
	256643.261	2 COB 840	61W	11320	9510	1/2	900	4,65
AS	265643.121	1 COB 840	21W	3870	2830	1/2	600	4,15
	265643.131	1 COB 840	30,5W	5660	4135	1/2	900	4,25
	265643.261	2 COB 840	61W	11320	8265	1/2	900	4,65
code + DALI	Driver dimmerabile DALI DALI dimmable driver							
code + VM	Driver dimmerabile Vmidnight Vmidnight dimmable driver							
900000.003	SPD 12kV Integrato con spia segnalazione di malfunzionamento SPD 12kV Embedded with malfunction warning light							
925600.000	Griglia di protezione Protection grid (IK10)*							
920003.006	Adattatore palo "T" Ø 40-60mm "T" pole adapter Ø 40-60mm							0,99
925603.001	Adattatore a palo "Deco" Ø 40 mm Pole adapter "Deco" Ø 40 mm							1,37
925603.002	Adattatore a palo "Deco" Ø 60 mm Pole adapter "Deco" Ø 60 mm							1,37



Gemini Lite SM 2 COB 840



Gemini Lite AS 2 COB 840



Gemini alettatura
Gemini fins



Gemini Lite alimentazione
Gemini Lite power supply



Gemini profilo
Gemini side view

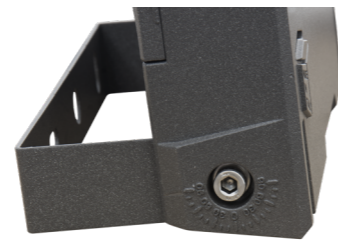

Scala goniometrica laterale
Lateral goniometric scale

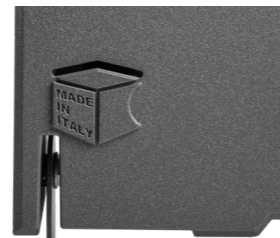

Autenticità prodotto, marchio Made in Italy
Product authenticity, Made in Italy brand

