

## ECLIPSE CYC

519543.242



### MARCHI

Marks



### DATI PRODOTTO

Product Data

<b>Tipologia di prodotto</b> Product type	Armatura stradale / Street lighting		
<b>Descrizione</b> Description	ECLIPSE CYC 2LM 740 700mA 32W		

<b>Grado di protezione</b> Degree of protection	IP	67	
<b>Protezione agli urti</b> Impact protection	IK	09	J 10
<b>Temperatura colore</b> Color temperature	[K]	4000	
<b>Classe di isolamento IEC</b> IEC Insulation class	II		

<b>Temperatura operativa</b> Operating temperature	[ta°]	-30/+45°C	
<b>Garanzia standard</b> Standard warranty	[Anni - Years ]	3	
<b>Regolazione della luce</b> Light control	Standard *(1)	On-Off	

### PRESTAZIONI APPARECCHIO

Luminaire Performances

<b>Flusso nominale / Corrente</b> Nominal flux / Current	Lm	5700	mA	700
<b>Consumo nominale</b> Nominal power	[W]	32		
<b>Efficienza sorgente LED</b> LED source efficiency	Lm/W	178		
<b>Flusso netto</b> Net flux	[Lm]	4220		
<b>Consumo reale</b> Total power	[W]	33,3		
<b>Efficienza luminosa</b> Luminous efficiency	[Lm/W]	127		
<b>Classe Energetica</b> Energy class (UE reg. 2019/2015)	B			

### STANDARD NORMATIVI

Normative Standards

EN 60598-1, EN 60598-2-3, EN 62471,  
EN 55015, EN 61547, EN 61000-3-2, EN 61000-3-3

### MECCANICHE & DIMENSIONI

Mechanics & Dimensions

<b>Dimensioni</b> Dimensions	[mm]	550	*	480	*	230
<b>Peso netto</b> Net weight	[Kg]	6,36				

<b>Dimensioni imballo</b> Packing dimensions	[mm]	620	*	580	*	140
<b>Peso lordo</b> Gross weight	[Kg]	7,87				
<b>Volume</b> Volume	[m³]	0,050				
<b>Q.tà prodotti per imballo</b> Products q.ty per package	[N°]	1				
<b>Q.tà imballi per pallet</b> Packaged q.ty per pallet	[N°]	30				
<b>Superficie esposta al vento</b> Surface exposed to the wind	[m²]	F	0,065	L	0,088	
<b>Interassi di fissaggio staffa</b> Bracket fixing distance	[mm - Ø]	-				
<b>Inclinazione</b> Tilt angle	[ ° ]	±7,5° / 90°				

### PRESTAZIONI ELETTRICHE

Power Performances

<b>Alimentazione</b> Power	Driver elettronico / Electronic driver				
<b>Tensione / Frequenza</b> Input Voltage / Frequency	[V] / [Hz]	220 ÷ 240	-	50/60	
<b>Corrente di spunto</b> Inrush current	[230V]	4,4	A	304 µsec	
<b>Fattore di potenza</b> Power factor	[Cosφ]	0,96			
<b>Distorsione armonica THD</b> Harmonic distortion THD	[%]	≤ 10			
<b>Protezione alla scarica</b> *(2) Surge protection	[kV]	Line-Earth 4KV, Line-Line 6KV			
<b>Flicker</b> Flicker	[%]	≤ 5			
<b>Umidità relativa</b> Relative humidity	[%]	>95			
<b>Max. Prodotti in serie</b> Max. pcs in series	CB B16A	4			

519543.242

### DISEGNO DIMENSIONALE

Dimensional drawing

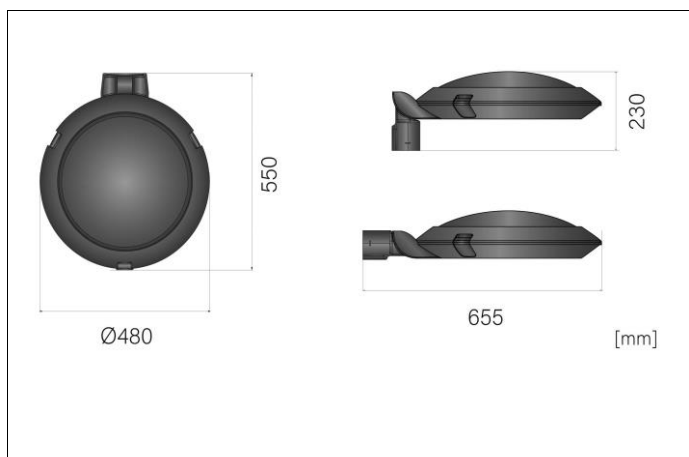

### FOTOMETRIA POLARE

Polar photometry

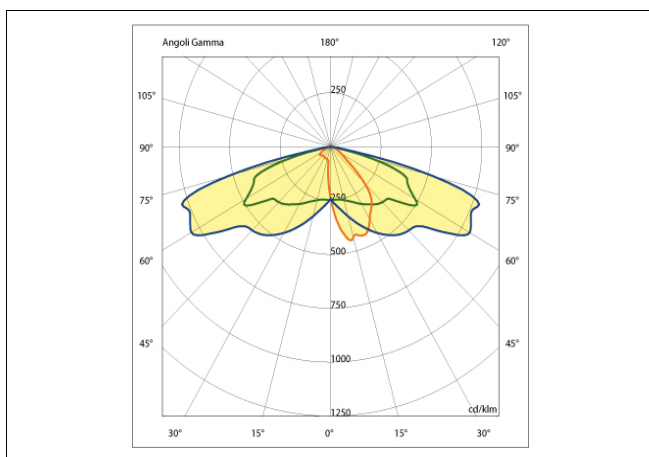

### MATERIALI & FINITURE

Materials & finishing

<b>Corpo</b> Body	Alluminio Pressofuso / Aluminum Die Casting [UNI EN 1676:2010 - EN AB-46100]
<b>Colore</b> Colour	Antracite / Anthracite
<b>Verniciatura</b> Painting	Verniciatura tipo C4 / Painting class C4 [UNI EN ISO 12944] hr < 1000 [ISO 9227]
<b>Diffuser</b> Diffuser	Vetro float silicato sodico-calcico / Soda lime silicate float glass UNI EN 572-1.2
<b>Riflettore</b> Reflector	-
<b>Viteria</b> Screws	Acciaio INOX ASTM 304 A2
<b>Guarnizione</b> Gasket	Silicone / Silicon
<b>Cablaggio incluso 1,5mt.</b> Wiring included 1.5mt.	2 x 1,5 H07RN-F L=1,5mt
<b>Resistenza alla nebbia salina</b> Saline mist resistance	[hr] < 1000

### SORGENTE LUMINOSA

Light source

<b>Tipologia Sorgente</b> Light Source	LED		
<b>Costruttore / N° / Modello</b> Maker / N° / Model	VOSSLOH	8	5050
<b>Indice di resa colore</b> Color Rendering Index	[IRC]	> 70	
<b>Uniformità colore</b> Uniformity & Chromaticity	[SDCM]	3 Step mc Adams	740
<b>Vita utile LED</b> Expected LED lifetime	L80 B10 54,000h [Ta 25°C]	-	L80 B10 54,000h [Ta 45°C]

### SISTEMA OTTICO

Optical System

<b>Distanza di soglia</b> Distance from the lightned object	[cm]	150	
<b>Sicurezza fotobiologica</b> Photobiological safety	Gruppo di rischio esente RG0 RG0 Risk-exempt group		
<b>Ottica</b> Optics	CYC		
<b>Abbagliamento Molesto</b> Light Output Ratio	[ULOR]	=	0%
<b>Efficienza dell'ottica</b> Optics efficiency	%	74%	0,74 100%
<b>Flusso totale disperso</b> Total lost flux	[%]	-	
<b>Materiale dell'ottica</b> Optic material	PMMA Anti-UV [ HB UL94 900° GWFI IEC 60695-2-12 SAE J576]		

### DOTAZIONI EXTRA DISPONIBILI A RICHIESTA

Available Accessories on request

<b>Regolazione della luce</b> <sup>*(1)</sup> Light control	.cod+VM	Reattore Dimmerabile Vmidnight
<b>Regolazione della luce</b> <sup>*(1)</sup> Light control	.cod+DALI	Reattore Dimmerabile DALI

