

ECLIPSE RSM

520543.262



MARCHI

Marks



DATI PRODOTTO

Product Data

Tipologia di prodotto Product type	Armatura stradale / Street lighting		
Descrizione Description	ECLIPSE RSM 2LM 740 700mA 48W		

Grado di protezione Degree of protection	IP	67
Protezione agli urti Impact protection	IK	09 J 10
Temperatura colore Color temperature	[K]	4000
Classe di isolamento IEC IEC Insulation class	II	

Temperatura operativa Operating temperature	[ta°]	-30/+45°C
Garanzia standard Standard warranty	[Anni - Years]	3
Regolazione della luce Light control	Standard *(1)	On-Off

PRESTAZIONI APPARECCHIO

Luminaire Performances

Flusso nominale / Corrente Nominal flux / Current	Lm	8550	mA	700
Consumo nominale Nominal power	[W]	48		
Efficienza sorgente LED LED source efficiency	Lm/W	178		
Flusso netto Net flux	[Lm]	7425		
Consumo reale Total power	[W]	50,0		
Efficienza luminosa Luminous efficiency	[Lm/W]	149		
Classe Energetica Energy class (UE reg. 2019/2015)		B		

STANDARD NORMATIVI

Normative Standards

EN 60598-1, EN 60598-2-3, EN 62471,
EN 55015, EN 61547, EN 61000-3-2, EN 61000-3-3

MECCANICHE & DIMENSIONI

Mechanics & Dimensions

Dimensioni Dimensions	[mm]	550	*	480	*	230
Peso netto Net weight	[Kg]	6,38				

Dimensioni imballo Packing dimensions	[mm]	620	*	580	*	140
Peso lordo Gross weight	[Kg]	7,90				
Volume Volume	[m³]	0,050				
Q.tà prodotti per imballo Products q.ty per package	[N°]	1				
Q.tà imballi per pallet Packaged q.ty per pallet	[N°]	30				
Superficie esposta al vento Surface exposed to the wind	[m²]	F	0,065	L	0,088	
Interassi di fissaggio staffa Bracket fixing distance	[mm - Ø]	-				
Inclinazione Tilt angle	[°]	±7,5° / 90°				

PRESTAZIONI ELETTRICHE

Power Performances

Alimentazione Power	Driver elettronico / Electronic driver				
Tensione / Frequenza Input Voltage / Frequency	[V] / [Hz]	220 ÷ 240	-	50/60	
Corrente di spunto Inrush current	[230V]	4,4	A	304	µsec
Fattore di potenza Power factor	[Cosφ]	0,96			
Distorsione armonica THD Harmonic distortion THD	[%]	≤ 10			
Protezione alla scarica *(2) Surge protection	[kV]	Line-Earth 4KV, Line-Line 6KV			
Flicker Flicker	[%]	≤ 5			
Umidità relativa Relative humidity	[%]	>95			
Max. Prodotti in serie Max. pcs in series	CB B16A	4			

520543.262

DISEGNO DIMENSIONALE

Dimensional drawing

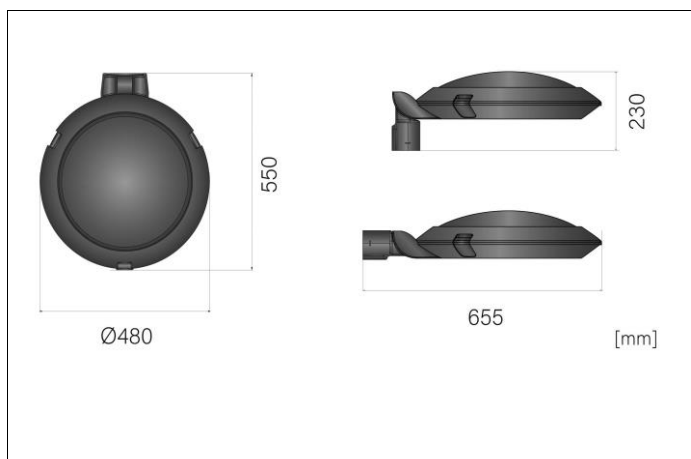

FOTOMETRIA POLARE

Polar photometry

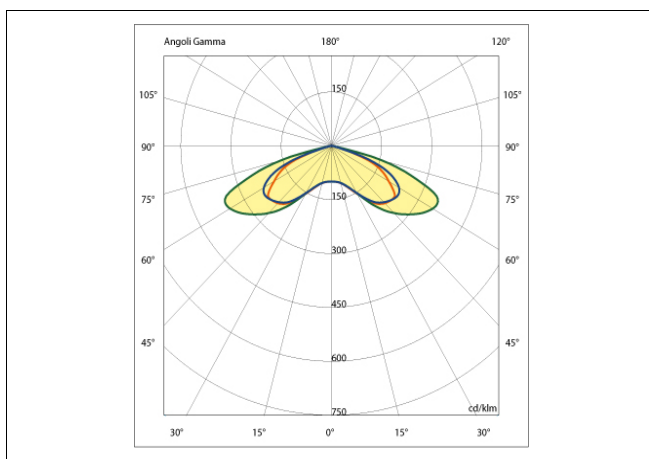

MATERIALI & FINITURE

Materials & finishing

Corpo Body	Alluminio Pressofuso / Aluminum Die Casting [UNI EN 1676:2010 - EN AB-46100]
Colore Colour	Antracite / Anthracite
Verniciatura Painting	Verniciatura tipo C4 / Painting class C4 [UNI EN ISO 12944] hr < 1000 [ISO 9227]
Diffuser Diffuser	Vetro float silicato sodico-calcico / Soda lime silicate float glass UNI EN 572-1.2
Riflettore Reflector	-
Viteria Screws	Acciaio INOX ASTM 304 A2
Guarnizione Gasket	Silicone / Silicon
Cablaggio incluso 1,5mt. Wiring included 1.5mt.	2 x 1,5 H07RN-F L=1,5mt
Resistenza alla nebbia salina Saline mist resistance	[hr] < 1000

SORGENTE LUMINOSA

Light source

Tipologia Sorgente Light Source	LED		
Costruttore / N° / Modello Maker / N° / Model	VOSSLOH	8	5050
Indice di resa colore Color Rendering Index	[IRC]	> 70	
Uniformità colore Uniformity & Chromaticity	[SDCM]	3 Step mc Adams	740
Vita utile LED Expected LED lifetime	L80 B10 54,000h [Ta 25°C]	-	L80 B10 54,000h [Ta 45°C]

SISTEMA OTTICO

Optical System

Distanza di soglia Distance from the lightned object	[cm]	150	
Sicurezza fotobiologica Photobiological safety	Gruppo di rischio esente RG0 RG0 Risk-exempt group		
Ottica Optics	RSM		
Abbagliamento Molesto Light Output Ratio	[ULOR]	=	0%
Efficienza dell'ottica Optics efficiency	%	87%	0,87 100%
Flusso totale disperso Total lost flux	[%]	-	
Materiale dell'ottica Optic material	PMMA Anti-UV [HB UL94 900° GWFI IEC 60695-2-12 SAE J576]		

DOTAZIONI EXTRA DISPONIBILI A RICHIESTA

Available Accessories on request

Regolazione della luce ^{*(1)} Light control	.cod+VM	Reattore Dimmerabile Vmidnight
Regolazione della luce ^{*(1)} Light control	.cod+DALI	Reattore Dimmerabile DALI



